

# Basic Tote Bag #4

Featuring Placemat Panels



## For one 2-panel tote

**A**  
Main Fabric  
Placemat Panel - 24" x 43"  
2 Panels (1/3 yd.)-2 placemats make 1 tote

**B**  
Sides, bottom (non-directional), & lining  
2/3 yd.

**C**  
Top border (all 4 sides of bag)  
1 Fat Quarter

**D**  
Handles  
1 Fat Quarter

## For one 1-panel tote

**A**  
Main Fabric  
Placemat Panel - 24" x 43"  
2 Panels (1/3 yd.)-1 placemat makes 1 tote

**B**  
Sides, bottom (non-directional), & lining  
7/8 yd.

**C**  
Top border (all 4 sides of bag)  
1 Fat Quarter

**D**  
Handles  
1 Fat Quarter

# Basic Tote Bag #4 featuring Placemat Panels

Please read all instructions carefully AND identify all fabrics before beginning.

All instructions include a 1/4" seam allowance and strips are cut selvage to selvage, unless stated otherwise.

## 1. Cut the following for a 2-Panel Tote:

**Fabric A** - PLEASE NOTE: Panels do not always print the size intended so panel edges may vary slightly from the color image. Fussy cut approximately 1/4" beyond outside edges of 2 panels to 11-1/2" x 16-1/2"

**Fabric B** - Cut (1) 13" strip, subcut (2) 13" x 19-1/2" lining rectangles. Cut (3) 2" strips, subcut (4) 2" x 11-1/2" side strips, and (2) 2" x 16-1/2" bottom strips

**Fabric C** - Cut (4) 1-3/4" x 19-1/2" top strips

**Fabric D** - Cut (3) 5" x 21" handle strips

**Fusible Fleece** - Cut (1) 14-1/4" strip, subcut (2) 14-1/4" x 19-1/2" rectangles. Cut (2) 2-1/2" strips

## 2. Piecing Order for a 2-Panel Tote:

1. Stitch a **Fabric B** 2" x 16-1/2" strip to bottom of a **Fabric A** panel. Add **Fabric B** 2" x 11-1/2" strips to right and left sides of panel, aligning top edges. Press seams to **Fabric B**. Stitch a **Fabric C** 1-3/4" x 19-1/2" strip to top of **Fabric A** panel. Make a total of 2 tote fronts (14-1/4" x 19-1/2" unfinished).

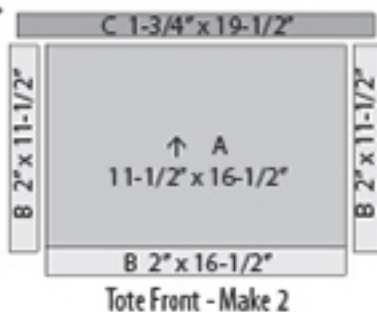
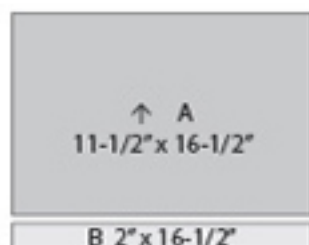

Arrows indicate orientation of directional prints.

2. Adhere fusible fleece to wrong side of each tote front. Quilt as desired. Trim excess fleece from bottom corners.

Shading of diagrams may vary depending on fabrics used.

3. Place tote fronts, right sides together, aligning edges. Sew together on right, left, and bottom edges.



Letters in italics indicate wrong side of fabric.

4. With tote right sides together, fold so 1 side seam aligns with bottom seam. Stitch together to form corner gusset. Repeat on opposite corner.

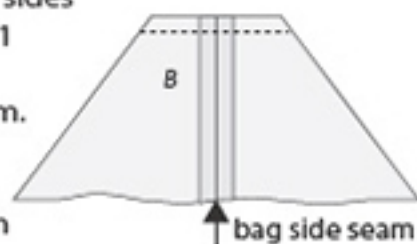

5. Stitch 3 **Fabric D** 5" x 21" strips together with diagonal seams.

6. Center 2-1/2" fusible fleece strips lengthwise on wrong side of **Fabric D** strip. Trim excess and fuse fleece to strip.

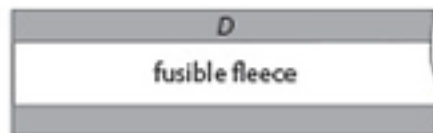

7. Fold long edges of **Fabric D** strip over fleece about 1-1/4" on each side and press in place. Fold **Fabric D** strip in half lengthwise. Top stitch both long edges of strip close to edges. Cut into two equal lengths for handles (approximately 1-1/4" x 26" unfinished).



8. Mark center of each tote front on top edge. With tote right side out, baste ends of handles about 4" from center on each side. Do not twist handles. Handles can be shortened if desired.

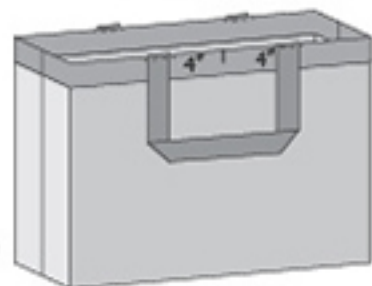

# Basic Tote Bag #4 featuring Placemat Panels

9. Stitch a **Fabric C** 1-3/4" x 19-1/2" strip to top of **Fabric B** 13" x 19-1/2" rectangle. Make a total of 2 tote linings (14-1/4" x 19-1/2" unfinished).

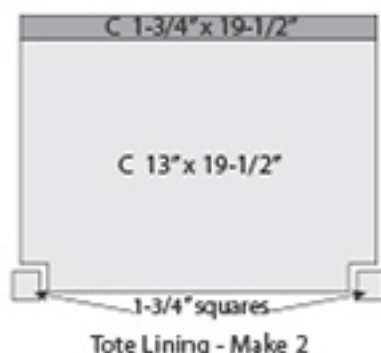

10. Cut a 1-3/4" square from bottom corners of each tote lining.

11. Place the 2 tote linings right sides together aligning all edges. Sew together on right and left sides. Sew along bottom, leaving a 6" opening for turning.

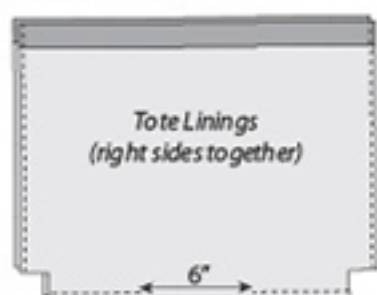

12. Referring to Step 4, fold lining and sew bottom corners to form gussets.

13. With tote lining wrong side out and tote right side out, insert tote into lining. Tuck handles between layers. Sew around top edge.

14. Turn tote right side out through opening in bottom of tote lining. Sew opening closed. Tuck lining inside tote and topstitch along top edge to complete tote bag (approximately 16" x 12 1/4" x 3").

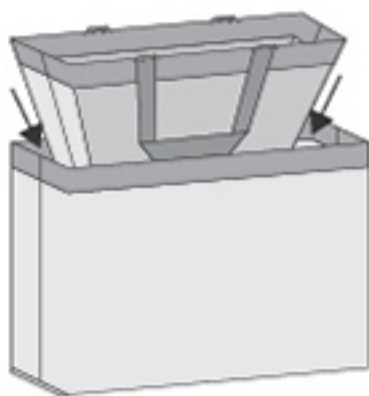

## 3. Cut the following for a 1-Panel Tote:

**Fabric A** - PLEASE NOTE: Panels do not always print the size intended. For this pattern, panels have a coping border added then trimmed so they will fit the quilt correctly.

Fussy cut approximately 1/4" beyond outside edges of 1 panel to 11-1/2" x 16-1/2"

**Fabric B** - Cut (1) 13" strip, subcut (2) 13" x 19-1/2" lining rectangles

Cut (1) 11-1/2" strip, subcut (1) 11-1/2" x 16-1/2" tote back rectangle and (4) 2" x 11-1/2" side strips

Cut (1) 2" strip, subcut (2) 2" x 16-1/2" bottom strips

**Fabric C** - Cut (4) 1-3/4" x 19-1/2" top strips

**Fabric D** - Cut (3) 5" x 21" handle strips

**Fusible Fleece** - Cut (1) 14-1/4" strip, subcut (2) 14-1/4" x 19-1/2" rectangles  
Cut (2) 2-1/2" strips

## 4. Piecing Order for a 1-Panel Tote:

1. Referring to Step 1 of the 2-Panel Tote directions, replace 1 **Fabric A** panel with **Fabric B** 11-1/2" x 16-1/2" rectangle.

2. Refer to Steps 2-14 of 2-Panel Tote directions to complete tote bag construction.

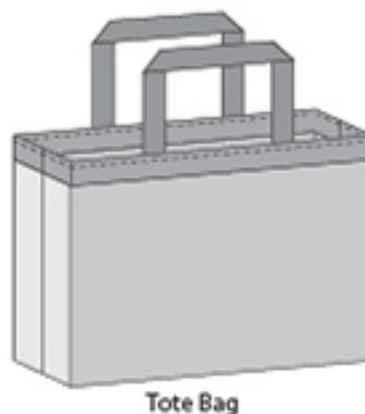

*Shading of diagrams may vary depending on fabrics used.*