

# NON-SLIP Cat's Cradle XL Tool

Double your fun by creating two Cat's Cradle XL units at a time! Make blocks in 8 different sizes, up to 8" finished.

Designed by Deb Heatherly

#CGRDH1XL

Made in USA



SEE A DEMO  
SCAN WITH ANY  
QR READER

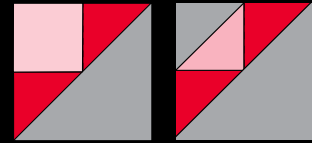

PO Box 1510  
Creative Grids® USA, Inc  
400 W. Dussel Dr. Ste B  
Maumee, OH 43537-1510  
www.creativegridsUSA.com

Creative Grids® UK, Ltd.  
Unit 23A Pate Road  
Leicester Road Industrial Estate  
Melton Mowbray  
Leicestershire, LE13 0RG England  
www.creativegrids.com

Creative Grids is covered by U.S. Trademark Registration No. 2,796,615

## NON-SLIP Cat's Cradle XL Tool cont.

Rotate the Cat's Cradle XL block to square up the other two sides.

Place the correct diagonal dashed line on the ruler, on the block diagonal seam line. (On larger sizes, the perpendicular dashed line that runs between the Cat's Cradle images should intersect the corner of the square.) Trim the outside edges of the large triangle to finish squaring the block. (Fig.10)

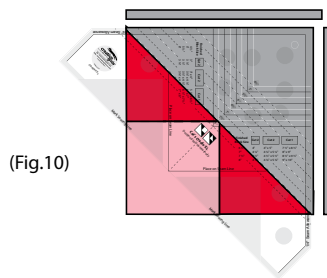

(Fig.10)

PO Box 1510  
Creative Grids® USA, Inc  
400 W. Dussel Dr. Ste B  
Maumee, OH 43537-1510  
www.creativegridsUSA.com

Creative Grids® UK, Ltd.  
Unit 23A Pate Road  
Leicester Road Industrial Estate  
Melton Mowbray  
Leicestershire, LE13 0RG England  
www.creativegrids.com

Creative Grids is covered by U.S. Trademark Registration No. 2,796,615



### Split Cat's Cradle XL (Fig. 11 & 12)

Following Steps 1 – 8, create the Cat's Cradle XL units and trim to desired size.

Cut two squares the appropriate size as listed in the chart below. Draw a diagonal line on the wrong side of these squares. Place the square - right sides together - on the square of the Cat's Cradle XL unit. (Fig. 11) Sew **ON** the drawn line. To eliminate bulk, trim 1/4" away from the seam line. Fold back the triangle and press. (Fig. 12)

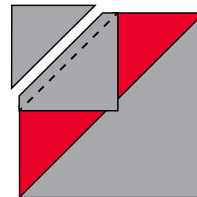

(Fig.11)

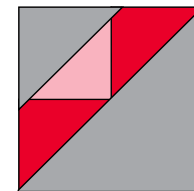

(Fig.12)

Size of Cat's Cradle XL Unit	Size of Square for Fold Back
4 1/2"	2 3/4"
5"	3"
5 1/2"	3 1/4"
6"	3 1/2"
6 1/2"	3 3/4"
7"	4"
7 1/2"	4 1/4"
8"	4 1/2"

\*Note: You can get different looks depending on where you place your darks and lights when creating the Cat's Cradle XL units.

# NON-SLIP Cat's Cradle XL Tool

Make Cat's Cradle XL units in 8 sizes.

Double your fun by creating two Cat's Cradle XL units from each set of squares and rectangles. Make blocks in 8 different sizes ranging from a finished size of 4-1/2" to 8". Trim the blocks with the Cat's Cradle XL Tool to create perfect triangle blocks without ever cutting a single triangle.

1. Following the chart on the Cat's Cradle XL tool, cut (2) squares, (2) small rectangles, and (1) large rectangle. Sew squares and small rectangles together as shown. **Press the seam toward the rectangle.** (Fig.1)

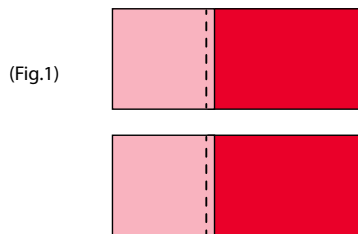

2. Stitch these units together along one long side with squares facing in opposite directions. (Fig. 2)

*Tip-As these units are sewn together, place the square leading into the machine on the bottom and the rectangle leading into the machine on top so that you can keep the top seam allowance from flipping directions.*

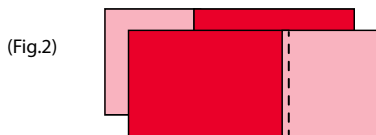

**BEFORE** you press the seam open, find the center of the block and clip to the stitching line. (Fig. 3) Then press the seams in opposite directions - once again toward the rectangles. Keep the stitching lines visible along both sides. You must press away from the squares in step 1 and 2. (Fig. 4)

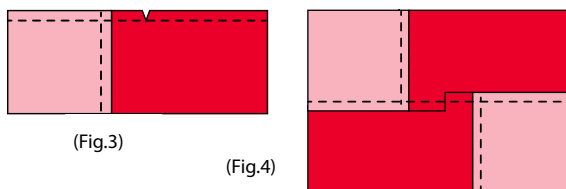

3. Place the Cat's Cradle XL tool on the wrong side of the pieced unit, lining up the "Place on Seam Line" markings on the stitched lines of the squares. Draw a line to mark the sewing line on both ends as shown. (Fig. 5)

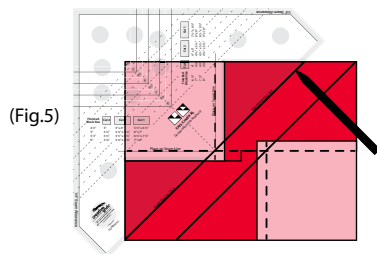

The drawn line must intersect the corner of the stitching lines on each square and extend to the edge of the rectangle. (Fig. 6)

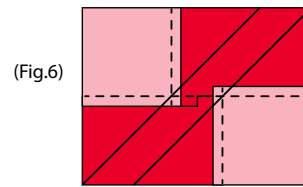

4. Place this pieced unit - right sides together - on the large rectangle. Stitch **ON** both drawn lines. Using the ruler as a guide, cut 1/4" away from the sewing lines. (Fig. 7-7a.)

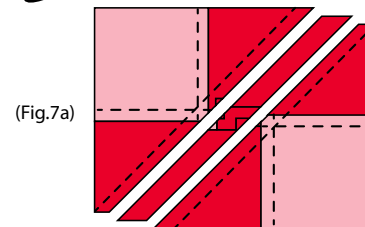
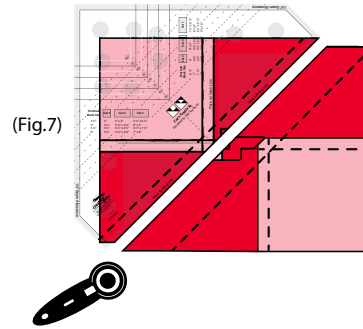

Open the units and press toward the large triangle. Two Cat's Cradle XL units are created with each set of squares and rectangles. (Fig. 8)

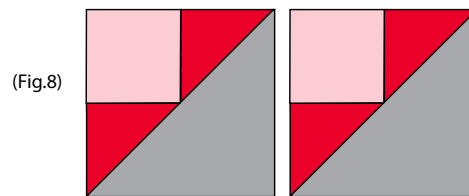

5. Use the corner of the Cat's Cradle XL tool to trim to size. Place the appropriate dashed diagonal line on the diagonal seam line and the correct black or white solid square on the stitching lines of the appropriately sized square. Make sure you are using the square that coincides with the size unit you are making. (Fig. 9) Trim the two adjoining sides. The markings on the tool show the **finished size**.

